

PRODUCT: UHF MALE TWIST-ON, STRAIGHT, FOR AIRCELL 5, LMR-200
PRODUCT CODE: E3760, Paratronic Oy

Description	Material	Note	General information	
Contact pin	Brass	1	Dimensions in millimeters (mm), unless otherwise specified. RoHS compliant. Directive 2015/863 with exemption 6(c) Note, finish, plating thickness in micro-inches, μ in (minimum): 1. Gold (3) over nickel (50) over copper (50) 2. Nickel (100) over copper (50) Cable/connector joint IP67. UHF coupling IP40.	Impedance not defined Frequency range DC - 300 MHz Insulator resistance $\geq 5 \text{ G}\Omega$ Resistance, center contact $\leq 5 \text{ m}\Omega$, outer c. $\leq 5 \text{ m}\Omega$ Test voltage 2200 V rms, working voltage 750 V rms Power handling $\leq 400 \text{ W @ 300 MHz}$
Insulators	PTFE	-		
Body	Brass	2		
Shell	Brass	2		
Heat shrink	With glue	-		

Assembly instruction:

1. Strip cable as shown

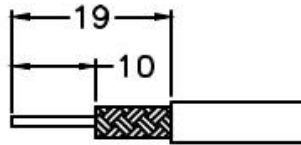

2. Bend braid back, remove foil and shorten insulator

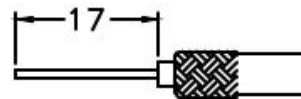

3. Put shell and heat shrink to cable.

Twist the connector on cable, until center conductor is even with pin tip

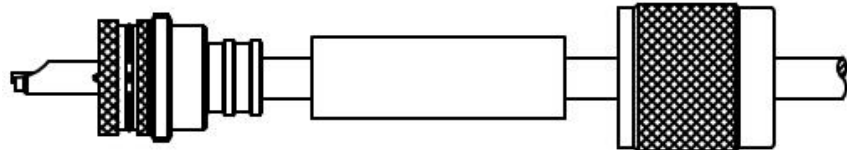

4. Solder the pin tip and apply heat shrink tubing.

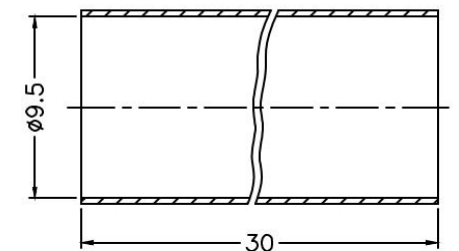
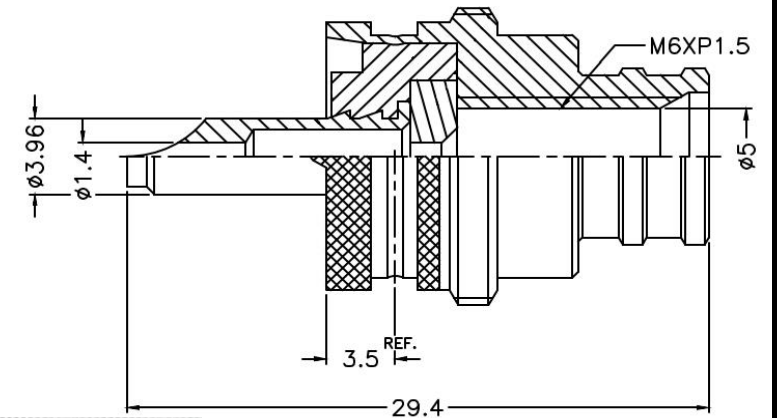
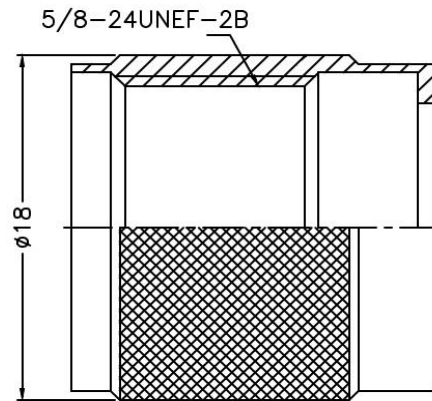
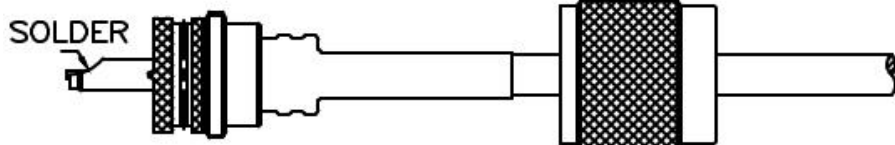

Title	Value
Drawing date	25.4.2023
Version	A
Website	www.paratronic.fi